

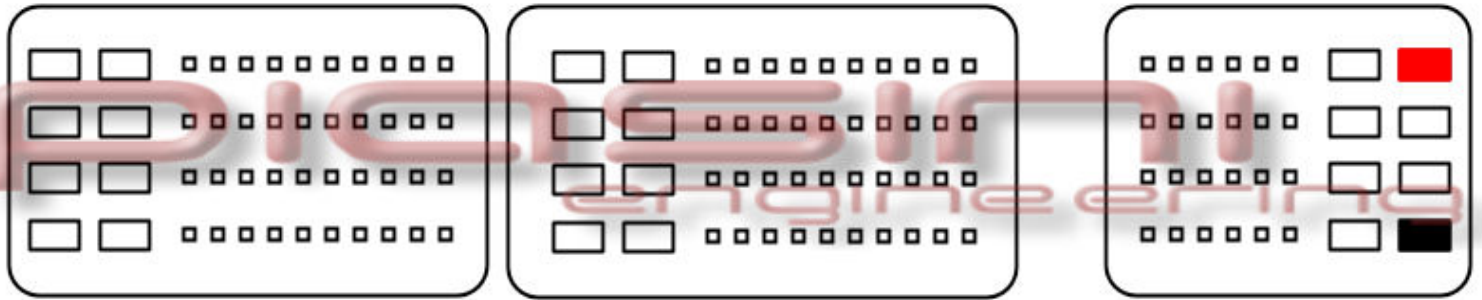

ECU : Nissan 3plug Long VAR1



Connect as below:

Serial Suite:

ECU Plug:

Red
Black

to
to

1 Pins Red (Power Supply +12 Volt)
1 Pins Black (Ground)

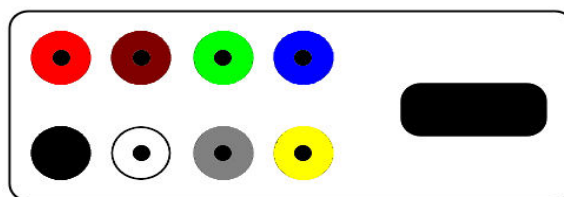

Where to connect the flat cable:

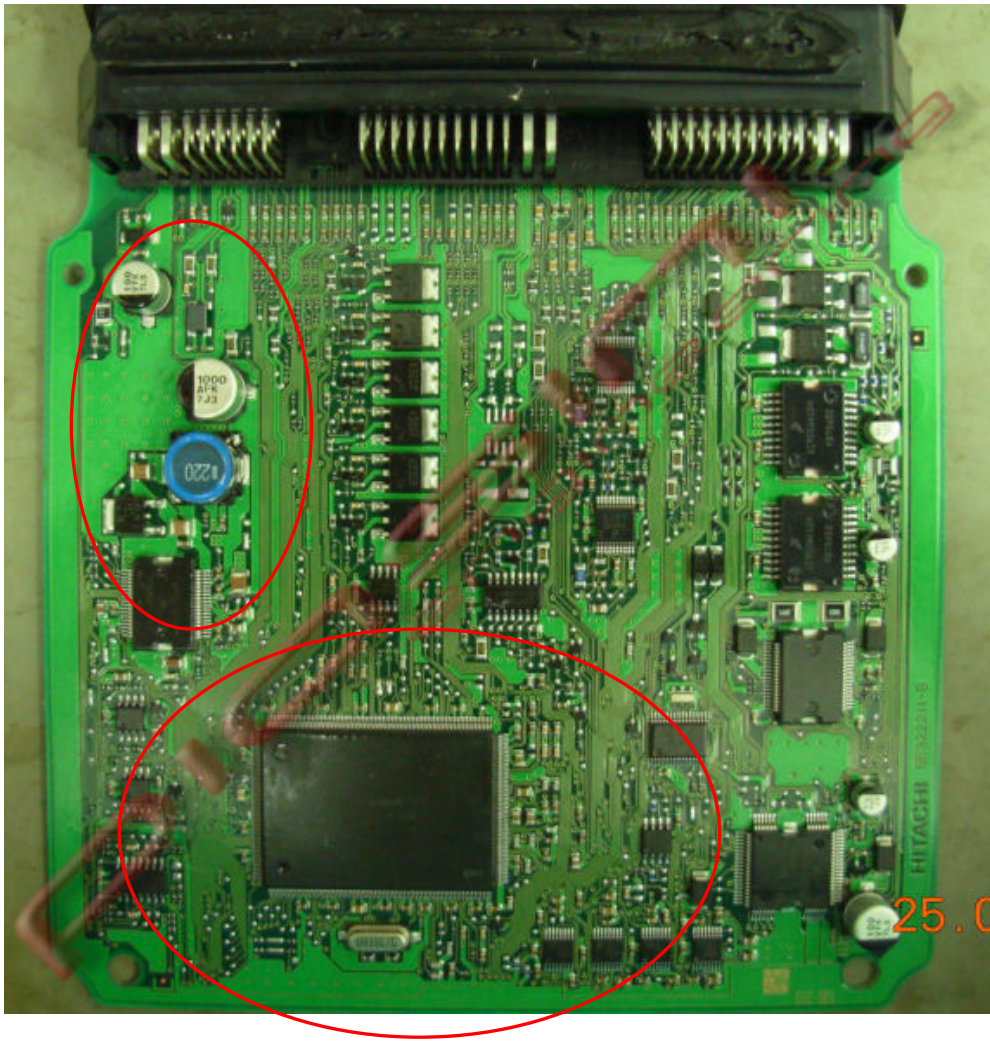

Backside:

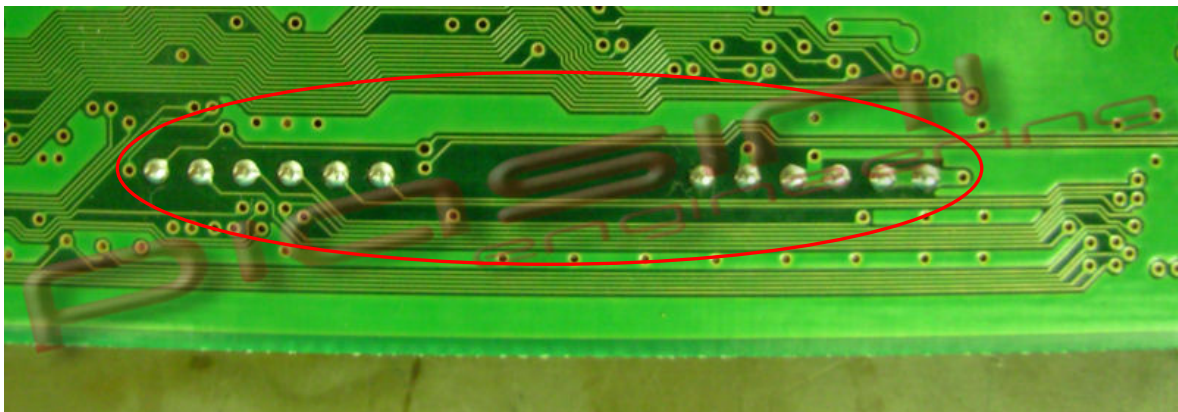

READ the ECU:

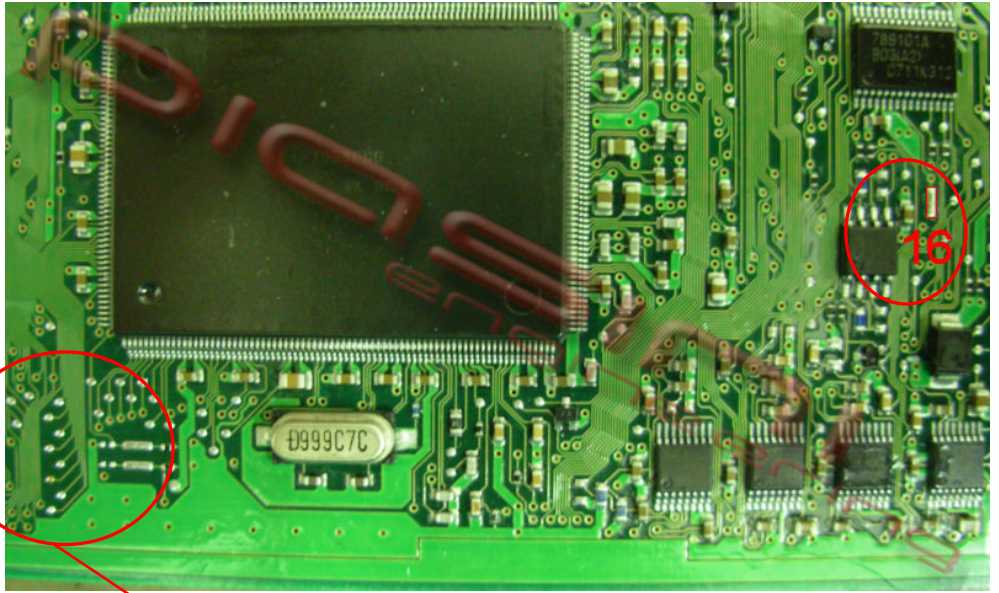
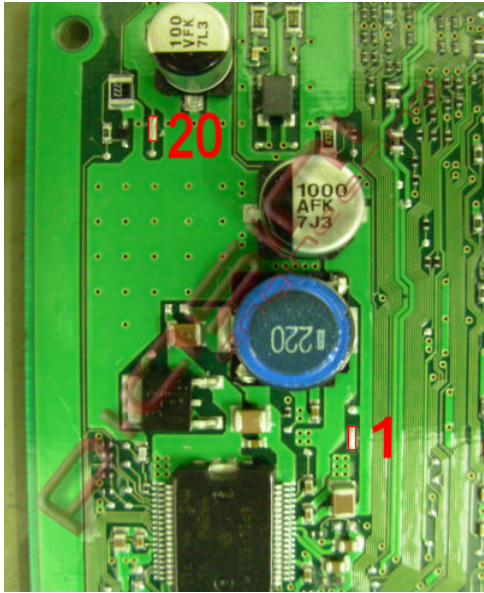

- 5
- 10
- 12
- 13
- 14
- 15
- 3
- 11

Backside:

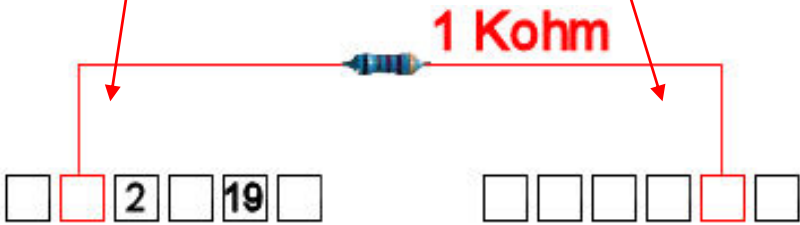
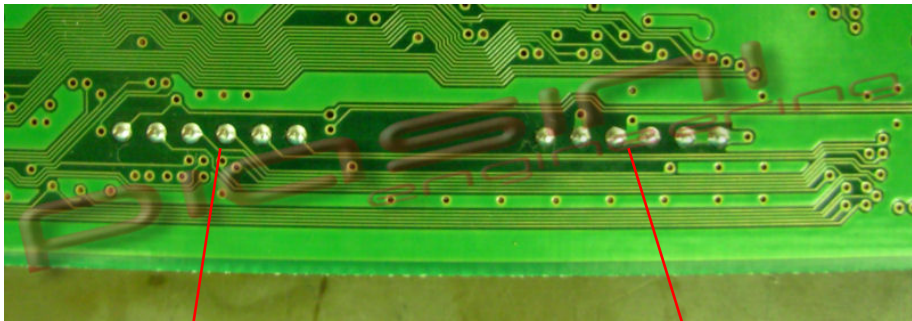

Connect the flat cable following the number like in the picture

WRITE the ECU:

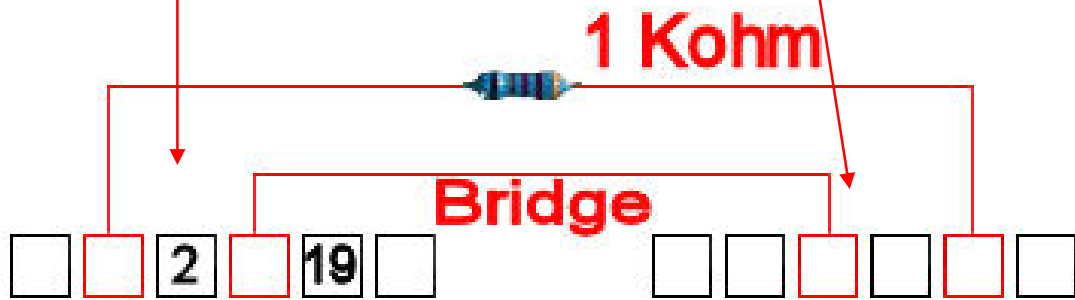
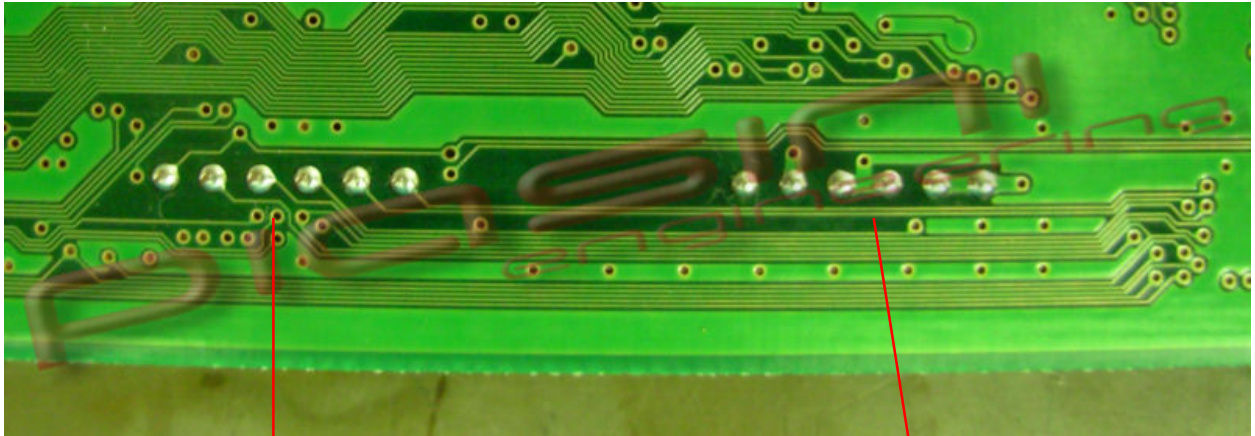

For write the ECU put 1 wire(Bridge) like in the picture.